

# Rail Systems

*The backbone of any ergonomic material handling system*



## **Ingersoll Rand offers:**

- ▶ Ceiling-supported workstation bridge cranes
- ▶ Freestanding workstation bridge cranes
- ▶ Monorails

**MMA-CERTIFIED**<sup>SM</sup>

**MONORAIL** Manufacturers<sup>®</sup>  
Association  
Workstation Cranes & Patented Track Systems

**Meets or Exceeds ANSI MH27.1 or MH27.2**

To review compliance requirements and confirm certification, visit [www.mmacertified.org](http://www.mmacertified.org)

*Ingersoll Rand Rail Systems are now MMA-Certified.*

# Zimmerman Series Rail Systems

## Ceiling-supported workstation bridge cranes:

- ▶ Ideal for high-volume production environments with limited floor space
- ▶ Capable of mounting parallel or perpendicular to overhead support steel
- ▶ Provide rectangular coverage for a single workstation, or an entire assembly line with multiple bridge cranes
- ▶ Capacities up to 3,000 lb

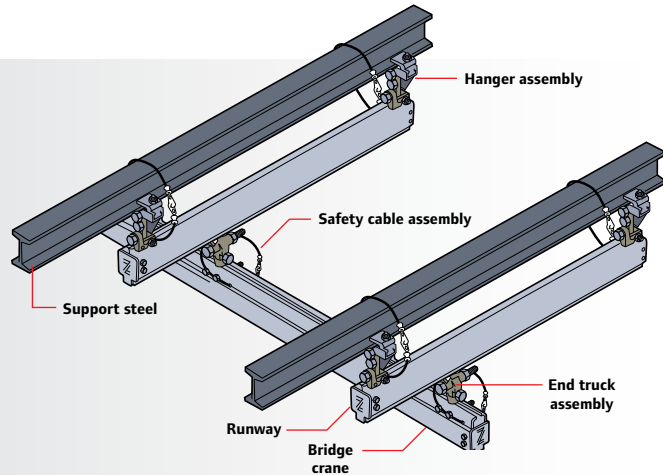

## Freestanding workstation bridge cranes:

- ▶ Floor supported to eliminate the need for overhead support structure
- ▶ Available in 1/4, 1/2, and 1 ton capacities and 4, 6, 8, 10, and 12 column designs to cover lengths up to 105 ft or more
- ▶ Lindapter® adjustable toe clamps make it simple to align runways for smooth operation
- ▶ Rugged design with gusseted column base plates
- ▶ Custom-designed structures available to meet special applications

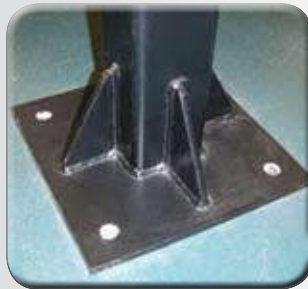

## Monorails:

- ▶ Provide simple single-axis transfer
- ▶ Curved sections available for navigating obstructions



ZRA1		ZRS2	
36"	15°	60"	10°
36"	30°	60"	15°
36"	45°	60"	30°
36"	60°	60"	45°
36"	90°	60"	60°
		60"	90°



# Zimmerman Series Rail Systems

## Profiles:

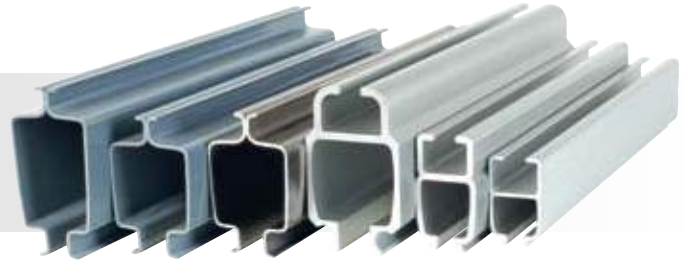

### Quality steel, aluminum, and stainless steel rail systems

Ingersoll Rand rails are available in three different materials and five different sizes to meet your specific material handling needs. The enclosed rail systems design reduces the accumulation of dirt and grime on the internal rolling surfaces, thus reducing rolling effort.



### The Ingersoll Rand Rail Systems **ADVANTAGE**

- ▶ **Lightweight and ergonomic** — Less than 1 percent rolling resistance
- ▶ **Precision running surface** — Aluminum, steel, and stainless steel available
- ▶ **Modular and flexible** — Bolted together; no welding required
- ▶ **Clean, maintenance-free operation** — No lubrication required
- ▶ **Safety** — Designed to meet or exceed all national and international standards
- ▶ **Now MMA Certified** — Certified by the Monorail Manufacturers Association to meet or exceed ANSI MH27.2 monorails and underhung cranes

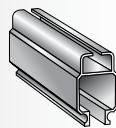
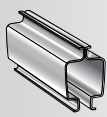
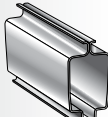
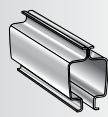
		Lightweight aluminum profiles			Rugged steel profiles		Clean stainless steel
		▶ Lightweight and available for long spans	▶ Extruded from aluminum alloy 6063-T6	▶ Clear anodized for a smooth, clean, corrosive-free surface	▶ Roll formed from 9 gauge, A569 hot-rolled steel	▶ Spot welded with automated welder for maximum strength	▶ Powder-coat painted for durability and smoothness
		▶ Engineered for clean room applications			▶ Ideal for the food and pharmaceutical industries	▶ Roll formed from 10 gauge, 316 L stainless steel	
		  			 		
		<b>ZRAT</b>	<b>ZRA1</b>	<b>ZRA2</b>	<b>ZRS2</b>	<b>ZRS3</b>	<b>ZRSS</b>
<b>Part No.</b>		31000	30200	30000	30500	30550	30500S
<b>Weight per Foot</b>	<b>lb</b>	2.15	4.10	7.60	8.00	8.90	8.86
	<b>kg</b>	0.97	1.86	3.45	3.60	4.00	4.01
<b>Vertical Height</b>	<b>in</b>	3.83	4.90	7.00	5.91	7.13	5.91
	<b>mm</b>	97	124	177	150	181	150
<b>Maximum Length</b>	<b>ft</b>	24	30	30	24	24	16
	<b>m</b>	7	9	9	7	7	5

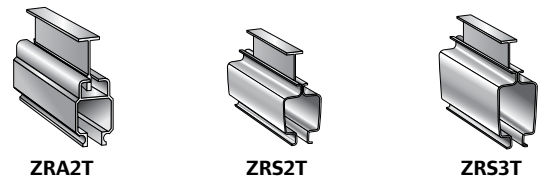

### Strongback profiles

- ▶ Reinforced profiles for added strength
- ▶ Uses the same hardware as standard profiles
- ▶ Increases span capacity

		<b>ZRA2T</b>	<b>ZRS2T</b>	<b>ZRS3T</b>
<b>Part No.</b>		30000T	30500T	30550T
<b>Weight per Foot</b>	<b>lb</b>	14.96	11.62	12.52
	<b>kg</b>	6.78	5.27	5.68
<b>Vertical Height</b>	<b>in</b>	13.0	7.83	9.20
	<b>mm</b>	330.0	198.8	233.6
<b>Maximum Length</b>	<b>ft</b>	30	24	24
	<b>m</b>	9	7	7

# Zimmerman Series Rail Systems

## Components:

### Safety first

The primary and vital concern of Ingersoll Rand is *safety*.

- ▶ **Deflection** — Ingersoll Rand rail is designed to not exceed 1/450 of span, in accordance with ANSI B30.11 monorail and underhung cranes
- ▶ **Safety cables** — We require the use of safety cables at all moving (hanger and end-truck) suspension points
- ▶ **Redundant end stops** — Available for extra safety
- ▶ **Load ratings** — Clearly marked on both sides of bridge cranes
- ▶ **Safety factor** — All hardware components are rated at a 5 to 1 safety factor based on meticulous tests performed at independent testing laboratories

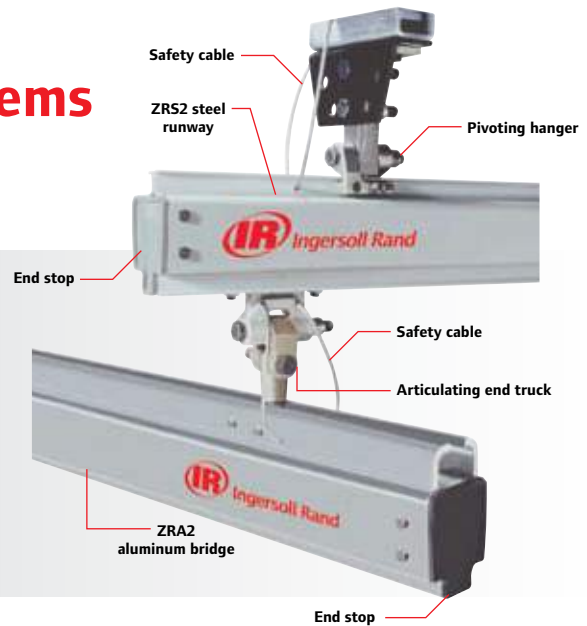

### Hangers

- ▶ Attach to I-beam, angle iron, C-channel, and other overhead steel shapes
- ▶ Close and rigid style hangers available for low headroom
- ▶ Adjustable-height hangers provide easy leveling
- ▶ Sway bracing for hanger drops >24" for added safety and stability

### Articulating end trucks

- ▶ Maximize the ability of the operator to precisely position the load
- ▶ Reduce fatigue by allowing the operator to move only the portion of the bridge crane near the load
- ▶ Dramatic improvements over typical rigid end-truck systems, which require the user to move the entire mass of the bridge crane for each operation

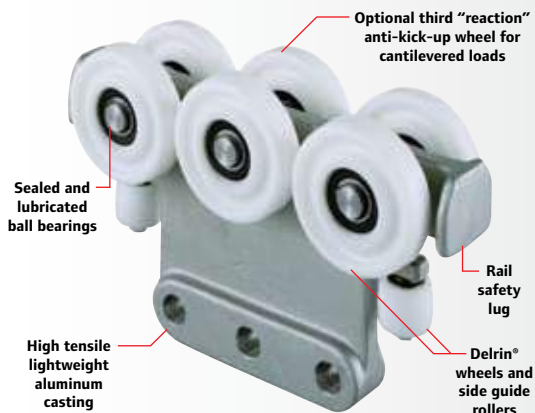

### Advanced trolley design

Ingersoll Rand trolleys are designed to work in conjunction with the enclosed track rail to reduce the rolling effort required to move a load. In fact, only a force equal to 1 percent of the total rolling weight is needed when moving loads.

- ▶ **Lightweight** — Trolleys are made from high-strength, lightweight aluminum castings
- ▶ **Injection molded wheels** — Provide for clean, wear-free operation that resists flattening
- ▶ **Sealed precision bearings** — In wheels and side guide rollers, they provide long life and reduced maintenance
- ▶ **Rail safety lug** — Prevents the body of the trolley from being pulled through the enclosed track rail
- ▶ **Versatile** — Ingersoll Rand-built trolleys are available for use in virtually every manufacturer's enclosed track rail system

# Zimmerman Series Rail Systems

## Accessories:

### Power supply

#### Air supply kits:

- ▶ Available in both 3/8" and 1/2" to fit application needs
- ▶ Includes filter regulator to ensure clean regulated air supply
- ▶ Provides complete utilization of the bridge and runway system

#### Electrical supply kits:

- ▶ Available with or without flat conductor cable
- ▶ Secured to rail system eliminating interference with operator

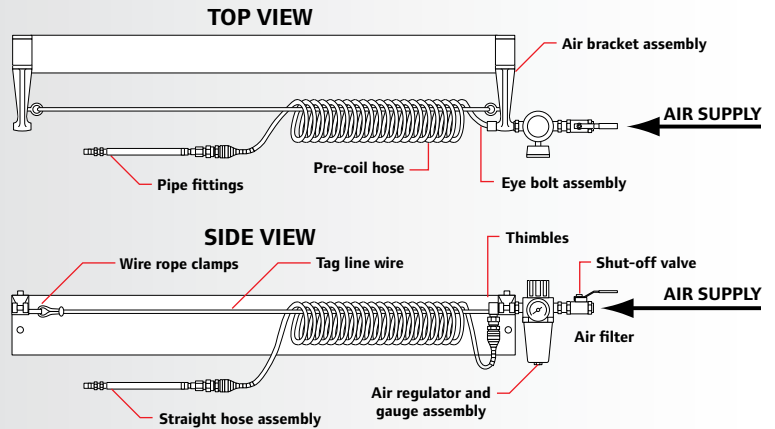

### Additional accessories:

#### Assorted load trolleys



Hoist trolley



Balancer suspension

#### Bumper trolley



- ▶ Safely separate multiple bridge cranes

#### Adjustable stop



- ▶ Easily adjust travel limit of bridge crane or load trolley

#### Inspection gates

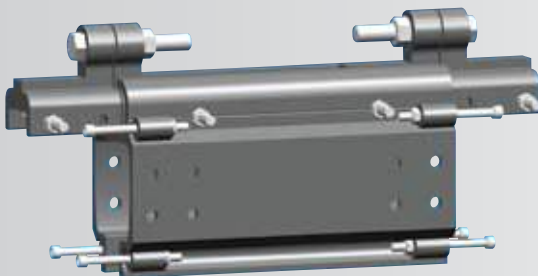

- ▶ Provide simple inspection of trolleys and end trucks

#### Insul-8™ electrification



- ▶ Clean electrification for long runs

#### Festooning trolleys



- ▶ Strap style
- ▶ Stamped
- ▶ Flat cable slider

#### Also available:

- ▶ Dual bridge kits for carriage applications
- ▶ Bridge extensions for reaching inside machines

Ingersoll Rand offers a full line of accessories to configure rail systems to your specific application

# Zimmerman Series Rail Systems

## Additional resources:

### The Assembly Configuration Engine (ACE)

ACE is extremely flexible, enabling you to quote projects in a variety of ways. You can use ACE as a simple, guided selling tool to automatically configure systems based on relatively few inputs, or you can put it to use as a fully customized system with multiple options that you pick and choose.

Quoting with the tool is simply a matter of selecting the type of rail system(s) needed, entering customer requirements, choosing accessories and parts, then inputting customer information for the proposal.

It's as easy as:

- 1 Select
- 2 Configure
- 3 Quote



Available to authorized Ingersoll Rand distributors at: [irtools.com/ACE](http://irtools.com/ACE)

## Rail Systems technical reference

**Overhead Rail System**  
Part No. 30291, 30292 & 30293

**ZBRAT Kit - ZBRAT/Parallel/Wide Flange/Part No. 30291**

**NOTE: SEE INSTALLATION MANUAL FOR EXPLODED VIEW.**  
WIDE FLANGE HANGERS FIT WELL ACCORDINGLY FROM 5" (127 mm) TO 10" (254 mm) FLANGE WIDTH.  
ULTIMATE STRENGTH..... 22,000 LB (9807 kg)  
YIELD STRENGTH..... 14,000 LB (6350 kg)  
CAPACITY..... 2,000 LB (907 kg)  
MINIMUM RAIL RADII..... 30" (762 mm)  
WEIGHT OF ASSEMBLY..... 16 LB (7.3 kg)

Item No.	Part No.	Description	Ass.
1	30291	Overhead Rail System	1
2	30292	Overhead Rail System	2
3	30293	Safety Cable Assembly (See Kit Box above)	1
4	30294	Hanger Kit (See Kit Box above)	1
5	30295	Hanger Kit, Wide Flange Beam	1
10			1688942-001

- ▶ Detailed specifications
- ▶ Load charts
- ▶ Dimensional info

Available at: [irtechpubs.com](http://irtechpubs.com)  
(Doc. #16598542)

## Drawings and CAD files available on the Web

**Lifting / Material Handling**

**Hangers**

For ease of installation, we offer a wide variety of fully assembled hangers in a variety of sizes for use of overhead steel (including E-beam) up to 12" wide. They can be installed perpendicular or parallel to the overhead steel and require a set flange to achieve desired capacity. The safety cable is required per hanger and one flange is required with 1 foot of width and is optional. Available in either light or medium duty to match the hanger's working capacity. The hangers are available in steel or aluminum weights up to 25" in length. For extra safety, we include a set of 2" diameter, 8' long, of 2" diameter, 1/2" cross bracing for stability.

**Get More Information**

**Drawings**

- ▶ 2D drawings
- ▶ 3D solid models
- ▶ Great for plant layouts

Available at: [irtools.com/lifting](http://irtools.com/lifting)